



ADJUSTABLE SPRING POWER - SURFACE GRADE 1 CLOSER

9000-TP SERIES

GRADE 1 • ADA HANDICAP



FEATURES

- **Model 9001-TP:** Adjustable spring power (1-6) Opening Force with adjustable back check and delayed action controlled by a separate regulating valve.
- ADA (Handicap) multi-sized closer with adjustable Spring Power for a range of sizes adjustable after installation.
- Two Speed Control Valves: Closing and Latching speeds controlled by separate regulating valves, adjustable after installation.
- Universal Application: Non handed for standard, top jamb or parallel arm installation (parallel arm bracket included).
- Rack and pinion mechanism contained in a high tensile precision cast aluminum housing.
- Stable hydraulic door check fluid for any climatic operation and constant lubrication.
- Furnished with a high impact molded PVC Dress Cover (door closer body casting is finished for use without the dress cover).
- Optional hold-open arms available.
- Hold-open arms are adjustable for holding from 90° to 180°



10 YEAR WARRANTY

- Adjustment Valves

FINISHES

- AL - Aluminum
- DU - Storefront Bronze

COMPLIANCE STANDARD

- ANSI A 156.4 Grade 1 Certified
- UL/C-UL Listed
- Underwriters' Laboratories Inc. Listed UL 10B and UL 10C Compliant for positive pressure
- Certified to Conform to UBC 7-2 (1997, UL 228)
- Barrier Free Operation to Comply with Federal Accessibility Standards (ADA): Complying with ANSI A117.1 (4.13.11)

TECHNICAL DIMENSIONS

Description	NO DRESS COVER
	9001-TP
A. Length of Closer Body	11 7/8"
B. Horizontal Mounting Holes	11 1/8"
C. Vertical Mounting Holes	3/4"
D. Overall Height	4 9/16"
E. Top of Door to Bottom of Closer	3 5/16"
F. Closer Body Height	2 13/16"
G. Projection from Door	2 9/16"

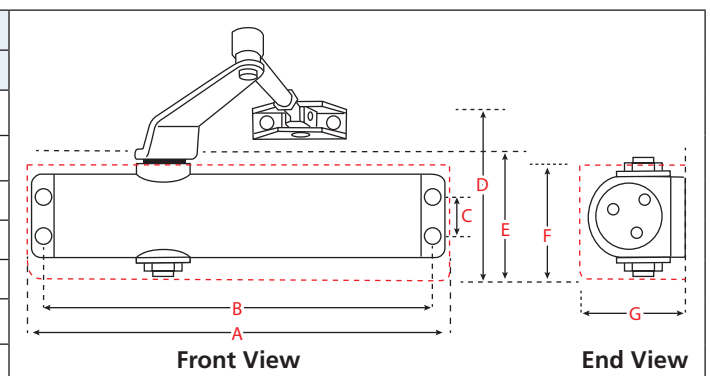

International Door Closers, Inc.

COPYRIGHT 2018 INTERNATIONAL DOOR CLOSERS, INC

West: 800-544-4422 • East: 800-225-6737

www.intldoorclosers.com

INSTALLATION TYPES

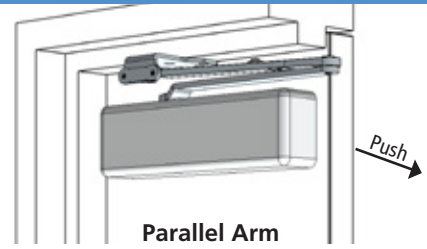
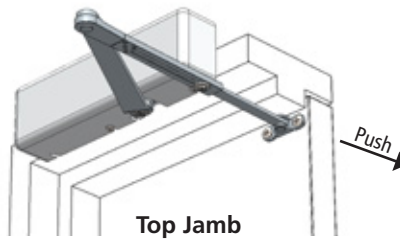
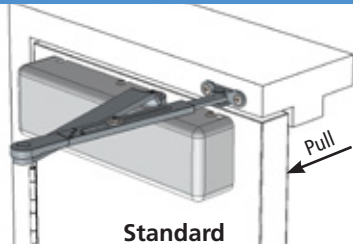









SELECTION CHART

TYPICAL INSTALLATIONS (REGULAR ARMS SHOWN) Hold-Open Arms are similar

MODEL NO.	TYPE
Back-Check / Delayed Action	
9001-TP	Regular Arm

PARTS AND ACCESSORIES - 9001-TP (PAINTED FINISH ONLY)

Parts	Description	Part #
	Complete Arm Assembly	901
	Hold-Open Forearm	522
	Top Jamb Forearm Extender	514
	Parallel Bracket for Regular Arm	525
	Flat Drop Bracket	9007
	Top Jamb Bracket	TJB-9000
	Thru Bolt & Grommet Nut (Set of 4)	TBGN-50
	Sex Nuts & Bolts	18-SN

Comparison Chart 9000 Series

International® Series 9000	Norton 8500	Yale 3000	Dorma 6600 & 7600	Dor-O-Matic/ LCN SC80 1460	Global TC400 TC500	Cal Royal 900	Sargent 1230 1430	Jackson 600	Parker 900

International Door Closers, Inc.

COPYRIGHT 2018 INTERNATIONAL DOOR CLOSERS, INC

West: 800-544-4422 • East: 800-225-6737

www.intldoorclosers.com