



STAINLESS STEEL CONTINUOUS HINGES

IDC stainless steel hinges are full height piano hinges that provide support for the full height of the door.

- For doors up to 600 lbs.
- 4'0" maximum door width
- Hinge leaves are 14 Ga., 304 stainless steel
- Pin is 1/4 diameter 304 stainless steel, barrel .438 diameter
- Knuckles are 2" long with Delrin™ bearings between each
- Hinges -Nominal Sizes 7' (83-1/8"), 8' (95") & 10' (118-3/4") are non-handed. 6'8" (78-3/4") & 7'2" (85") are handed
- Special lengths available
- Standard finish-US32D
- Self-drilling screws standard, security screws available (wood or machine)
- Fire Rating-UL and ULC fire Listed
 - 3 hours-hollow metal door
 - 90 min.-hollow metal and composite core wood fire door
 - 20 min.-wood door
- Custom Cut outs available

All dimensions in () are actual hinge lengths.

IDCA500 EDGE MOUNT CONCEALED

- For beveled or square edged doors
- For 1-3/4" doors
- For high traffic, high abuse doors
- Heavy-duty 14 Gauge 304 Stainless Steel
- US32D Satin Stainless Steel
- No exposed fasteners when door is closed
- Self drilling screws
- Supports door weights up to 600 lbs.
- 4'0" Maximum door width
- Electrical modifications available
- UL & ULC fire listed

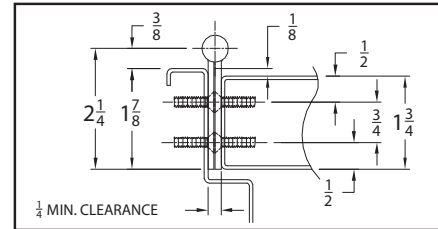

IDCA505 EDGE GUARD

- Concealed
- For square edged doors
- For 1-3/4" doors
- For high traffic, high abuse doors
- Heavy-Duty 14 Gauge 304 Stainless Steel
- US32D Satin Stainless Steel
- No exposed fasteners when door is closed
- Self drilling screws
- Supports door weights up to 600 lbs.
- 4'0" Maximum door width
- Door edge lip on both faces of door
- Protects door edge
- Adjustable to accommodate slight variances in door thickness
- For specialty door – Use with A538CS or A538CB
- Electrical modifications available
- UL & ULC fire listed

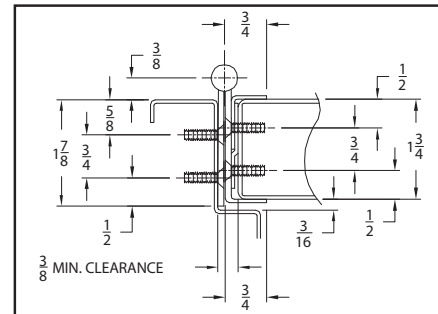

IDCA511 SWING CLEAR WITH EDGE GUARD

- Concealed
- Flush mount
- For square edged doors
- For 1-3/4" doors
- For high traffic, high abuse doors
- Heavy-Duty 14 Gauge 304 Stainless Steel
- US32D Satin Stainless Steel
- Door edge lip on stop side only
- Self drilling screws
- Supports door weights up to 600 lbs.
- 4'0" Maximum door width
- No exposed fasteners when door is closed
- Meets ADA requirements
- UL & ULC fire listed

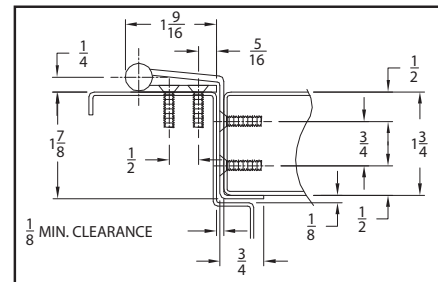

IDCA515 WITH EDGE GUARD

- Concealed
- For square edged doors
- For 1-3/4" doors
- For high traffic, high abuse doors
- Heavy-Duty 14 Gauge 304 Stainless Steel
- US32D Satin Stainless Steel
- Door edge lip on stop side only
- Self drilling screws
- Supports door weights up to 600 lbs.
- 4'0" Maximum door width
- No exposed fasteners when door is closed
- UL & ULC fire listed

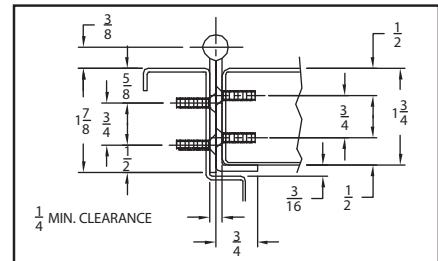

STAINLESS STEEL CONTINUOUS HINGES (cont.)

HALF SURFACE

IDCA503 SURFACE MOUNTED DOOR LEAF

- For beveled or square edged doors
- For 1-3/4" doors
- For high traffic, high abuse doors
- Heavy-Duty 14 Gauge 304 Stainless Steel
- US32D Satin Stainless Steel
- Self drilling screws
- Supports door weights up to 600 lbs.
- 4'0" Maximum door width
- Decorative fastener cover
- Current transfer prep available (frame leaf only)
- UL & ULC fire listed

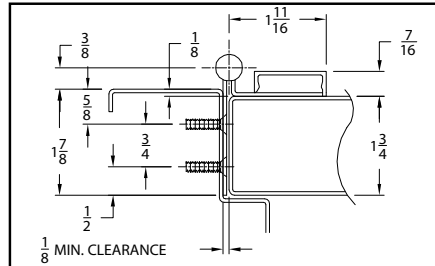

IDCA504 SURFACE MOUNTED FRAME LEAF

- For beveled or square edged doors
- For 1-3/4" doors
- For high traffic, high abuse doors
- Heavy-Duty 14 Gauge 304 Stainless Steel
- US32D Satin Stainless Steel
- Self drilling screws
- Supports door weights up to 600 lbs.
- 4'0" Maximum door width
- Decorative fastener cover
- Current transfer prep available (door leaf only)
- UL & ULC fire listed

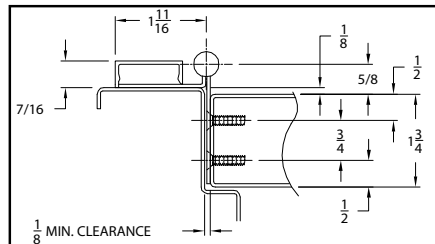

IDCA506 WITH EDGE GUARD

- For square edged doors
- For 1-3/4" doors
- For high traffic, high abuse doors
- Heavy-Duty 14 Gauge 304 Stainless Steel
- US32D Satin Stainless Steel
- No exposed fasteners when door is closed
- Self drilling screws
- Supports door weights up to 600 lbs.
- 4'0" Maximum door width
- Door edge lip on stop side
- Protects door edge
- Decorative fastener cover
- Current transfer prep available (door leaf only)
- UL & ULC fire listed

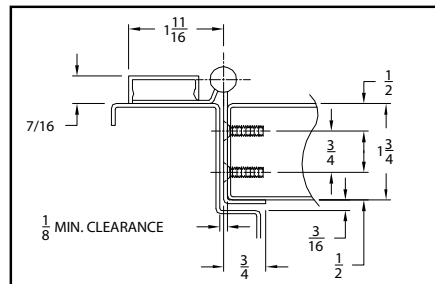

FULL SURFACE

IDCA502 FULL SURFACE/FLUSH MOUNT

- For beveled or square edged doors
- For 1-3/4" doors
- For high traffic, high abuse doors
- Heavy-Duty 14 Gauge 304 Stainless Steel
- US32D Satin Stainless Steel
- No exposed fasteners when door is closed
- Self drilling screws
- Supports door weights up to 600 lbs.
- 4'0" Maximum door width
- Decorative Fastener Covers
- UL & ULC fire listed

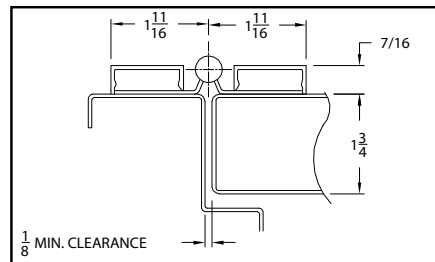

12 GAUGE STAINLESS STEEL PIN AND BARREL CONTINUOUS HINGES A5500

- Full Mortise Edge Mount
- Used on high-traffic, high-abuse doors
- Heavy-Duty 12 Gauge 304 Stainless Steel
- US32D Satin Stainless Steel
- No exposed Fasteners when door is closed
- Supplied with 12-24x1/2 Phillips Undercut Flat Head Machine Screw S.S.
- Supports door weights up to 900 lbs.
- 4'-0" Maximum door width
- Nominal Sizes 7', 8' & 10' are non-handed
- 6'8" & 7'2" are handed hinges
- 1/4" diameter stainless steel pin
- Electrical modifications available
- UL fire listed

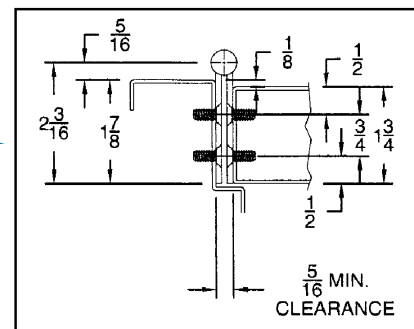

Visit our website: intldoorclosers.com

EAST:
1920 Air Lane Drive • Nashville, TN 37210
(615) 885-7060 • (800) 225-6737 • FAX: (615) 885-0903

WEST:
1140 North Kraemer Place • Anaheim, CA 92806
(714) 666-0390 • (800) 544-4422 • FAX: (714) 666-2215

STAINLESS STEEL CONTINUOUS HINGES (cont.)

STAINLESS STEEL POWER TRANSFER HINGES

CONCEALED THRU WIRE

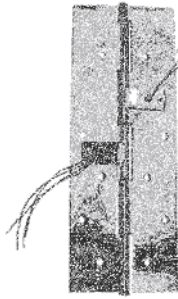

- For all full concealed models (except A511)
- TW2 - (2) 18ga. wire 1 location
- TW4 - (4) 28ga. wire 1 location
- TW8 - (8) 28ga. wire (2) - 4 wire locations
- For all full concealed models add suffix TW2, TW4 or TW8
- Call factory or go on-line for order form

MOVEABLE

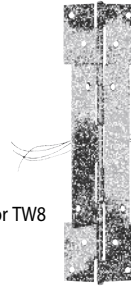

- Cut to allow access for TW, CT, ES and AMS wiring between hinge and frame or door
- For all full concealed models (except A511)
- Add suffix M

CONTINUOUS HINGE MODIFICATIONS

- Special Lengths-Indicate Handing
- Hospital Tip-Suffix HT
- Dutch Door Prep-Suffix DD, indicate handing, clearances, door and frame heights
- Blank-No holes for special applications
- Standard Edge Guard Cut-out
 - 4-7/8' ASA Strike 161 Latch 86 Mortise Manual Flush Bolt Automatic Flush Bolt
- Security Stud-Suffix SS, stainless steel studs mounted to frame leaf. Corresponding holes drilled in door leaf. Special prep required for frame and door
- Sheared Leaf-Suffix SL for narrow door thickness. Specify distance from pin centerline to heel edge of hinge.
- Custom Hole Pattern-Suffix CH, any hole dimension or pattern other than IDC standard. Indicate hole size and dimensions.

ELECTRICAL MODIFICATIONS

- Concealed Power Transfer-Suffix TW2, TW4 or TW8
- Power Transfer Contact Switch- suffix CT-4 or CT-8, for 16 amp surge current, 1/4"-20 screws posts to accommodate any gauge wire, no wire furnished.
- Lead-Lined Cover-Suffix LL for surface mount only.
- Current Transfer Prep-Suffix PT, indicate position and handing
- Electric Power Transfer-PT105 (11.5") or PT180 (20.0"). Does not include hinge, hinge power transfer prep or Security bracket (PTS).
- Exposed Monitoring Switch-Suffix ES available in A500, A503, A504, A505 & A515.
- Adjustable Monitoring Switch-Suffix AMS.

Contact factory or go on-line for order forms for electrical modifications or standard/custom cutouts.



Visit our website: intldoorclosers.com

EAST:
1920 Air Lane Drive • Nashville, TN 37210
(615) 885-7060 • (800) 225-6737 • FAX: (615) 885-0903

WEST:
1140 North Kraemer Place • Anaheim, CA 92806
(714) 666-0390 • (800) 544-4422 • FAX: (714) 666-2215

STAINLESS STEEL CONTINUOUS HINGES (cont.)

DOOR EDGE GUARDS

- Standard lengths 78-3/4", 83-1/8", 85", 96", 118-3/4"
- Special lengths available
- For bevel edge door (Suffix B) or square edge door (Suffix S)
- For 1-3/4" door
- Material 16 Gauge, 304 Stainless Steel
- For high traffic, high abuse doors
- Standard cutouts available
- Custom Cut-outs available as required
- Non-handed (except with cutouts)

A528 EDGE GUARD

- 3/4" door edge lip, one side
- Bevel and square edge available

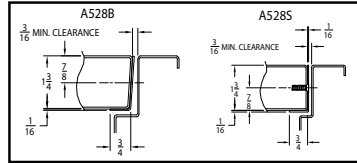

STANDARD CUTOUTS

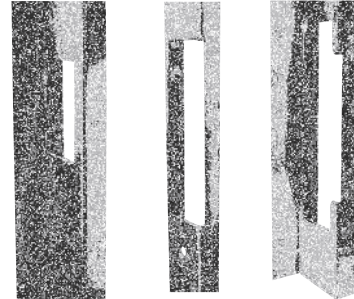

161 Latch

86 Mortise

4-7/8"
ASA Strike

A538C EDGE GUARD

- 3/4" door edge lip, both sides
- Bevel and square edge available

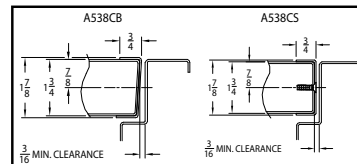

A548T EDGE GUARD WITH ASTRAGAL

- 3/4" door edge lip, both sides with astragal one side
- Bevel and square edge available

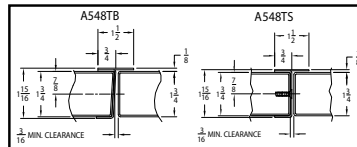

- Other cutouts or order forms available online (www.intldoorclosers.com) or contact factory



Visit our website: intldoorclosers.com

EAST:
1920 Air Lane Drive • Nashville, TN 37210
(615) 885-7060 • (800) 225-6737 • FAX: (615) 885-0903

WEST:
1140 North Kraemer Place • Anaheim, CA 92806
(714) 666-0390 • (800) 544-4422 • FAX: (714) 666-2215