



EXIT DEVICE
5000 SERIES
GRADE 2



International Door Closers IDC 5000 Series Exit Devices meet the Life and Fire Safety Codes as prescribed by UL and ANSI / BHMA 156.3 standards. These durable devices are designed for both standard and commercial applications. The 5000 Series were tested and approved by Underwriters Laboratories (UL, USA and ULC, Canada) and listed to comply with UL 10C, and Uniform Building Code Standard 7-2, "Fire Test of Door Assemblies" (1997).

FEATURES

- All devices are non-handed design
- Auxiliary guarded latch deadlocks latch bolt automatically locks when the door is closed
- High shock-resistant latching mechanical design for protection from vandalism
- All inside components are made of high rust-resistant alloy or heavy electroplated steel
- Baked powder coating, electroplated or architectural base finishes are used on all exposed surfaces
- Outside trims are provided by rose and escutcheon lever or knob in a variety of styles
- All trim, features a through-bolted design to the devices that allow easy installation but not to compromise on security
- With a dogging mechanism, users have a choice of hex-key or cylinder operated design for a positive push-pull door action during peak traffic time

International Door Closers, Inc.

COPYRIGHT 2017 INTERNATIONAL DOOR CLOSERS, INC

West: 800-544-4422 • East: 800-225-6737

www.intldoorclosers.com



5510S Panic Rim Exit Device
5510F Fire Rim Exit Device



5530S Panic SVR Exit Device
5530F Fire SVR Exit Device



5610S Narrow Design
Panic Rim Exit Device



5630S Narrow Design
Panic SVR Exit Device

**5510 SERIES RIM EXIT DEVICE
5530 SERIES SVR EXIT DEVICE**

These two series models are wide stile design,
UL listed Panic Hardware or Fire Exit Hardware.

Rim Type- Ideally suited for:

- Any single exterior doors
- Any panic or fire rated interior single door and all exit doors in factories, hospitals, apartments, office buildings
- Indoor parking lots

SVR Type- Ideally suited for:

- Any pairs of emergency exit doors
- Pairs of doors in cross-corridors
- Double egress applications
- Passage doors in hospitals, factories or any public buildings

International Door Closers, Inc.

COPYRIGHT 2017 INTERNATIONAL DOOR CLOSERS, INC

**5610 NARROW DESIGN PANIC RIM DEVICE
5630 NARROW DESIGN PANIC SVR DEVICE**

These two models are narrow stile design,
UL listed Panic Hardware

Rim Type and SVR Type

Both Types- Ideally suited for:

- Glass door
- Aluminum entrance doors
- Passage doors
- Full glass doors in stores, resorts and hotels

West: 800-544-4422 • East: 800-225-6737

www.intldoorclosers.com

RIM EXIT DEVICES

MODEL 5510S PANIC-RATED RIM EXIT DEVICE - For wide stile and flush doors use
MODEL 5510F FIRE-RATED RIM EXIT DEVICE - For wide stile and flush doors use



Application

- For use on single or double doors with mullion (Fire rated device must use on 4' x 8' single or up to an 8' x 8' double fire labeled doors).
- Fits for 1 3/4" (44mm) thick standard RHR or LHR hollow metal doors & wood doors Other than standard an 1 3/4" is available but specify door thickness when ordering.
- Minimum Stile width: 3 1/2" (90mm)



531 Strike Shim

Furnished with 532 Strike together made of steel and is plated. This shim is 1/8" thick and is used to prepare doors with a 1/2" stop. This will correct the distance between the device latch and the surface. If the frame has a 5/8" stop a shim is not needed.



532 Panic Rim Strike

Surface applied standard on 5000 Series panic rim exit devices. Stainless Steel with a plated roller.



533 Fire Rim Strike

Surface applied. Standard on 5000 Series fire rim devices. It is 100% stainless steel including a roller.

*Fire rated SVR device has no mechanical dogging. (Dogging device is not permitted on fire-rated exit device)

Specifications

Device Head Cover	Stainless Steel, nonferrous alloy
Chassis	Steel plated
Mechanism Housing	Steel or Stainless Steel
Push Bar	Steel or Stainless Steel
End Cap	Steel or Stainless Steel
Latch Bolt	100% Stainless Steel, dead locking type with an 11/16" throw
Deadlocking Latch	100% Stainless Steel with 5/8" (16mm) throw
Strikes	531 & 532 Rim (panic rated) 533 Rim (fire rated)
Handing	Non-handed
Mounting Fasteners	Machine screws furnished standard Sex Nut & Bolt (SNB) are required for wood doors. Order SNB separately including standard.
Dogging*	Hex key dogging standard (Allen-type key furnished)
Dogging Options	Cylinder dogging or less dogging
Finish	605, 630, 689, 690, four finishes
Dimension	See Spec. Sheet
Device Length	See Spec. Sheet
UL Listed	For Panic Hardware, see model 500SA For Fire Exit Hardware, see model 510AF

International Door Closers, Inc.

COPYRIGHT 2017 INTERNATIONAL DOOR CLOSERS, INC

West: 800-544-4422 • East: 800-225-6737
www.intldoorclosers.com

SURFACE VERTICAL ROD EXIT DEVICES

MODEL 5530S PANIC-RATED SVR EXIT DEVICE - For wide stile and flush doors use

MODEL 5530F FIRE-RATED SVR EXIT DEVICE - For wide stile and flush doors use

Application

- For use on all single doors or double doors where two-point latch is desirable (inactive leaf of double door). Fire rated device must use on 4' x 8' single or 8' x 8' double fire labeled doors.
- Fits for 1 3/4" (44mm) thick standard non-handed hollow metal and wood doors, other than standard 1 3/4" is available but specify door thickness when ordered.
- Minimum Door Stile width: 3 1/2" (90mm)



534 Top Strike

Applied to surface of stop.
Hardened steel and plated.



537 Bottom Strike

Applied to surface of floor.
Nonferrous alloy and plated.

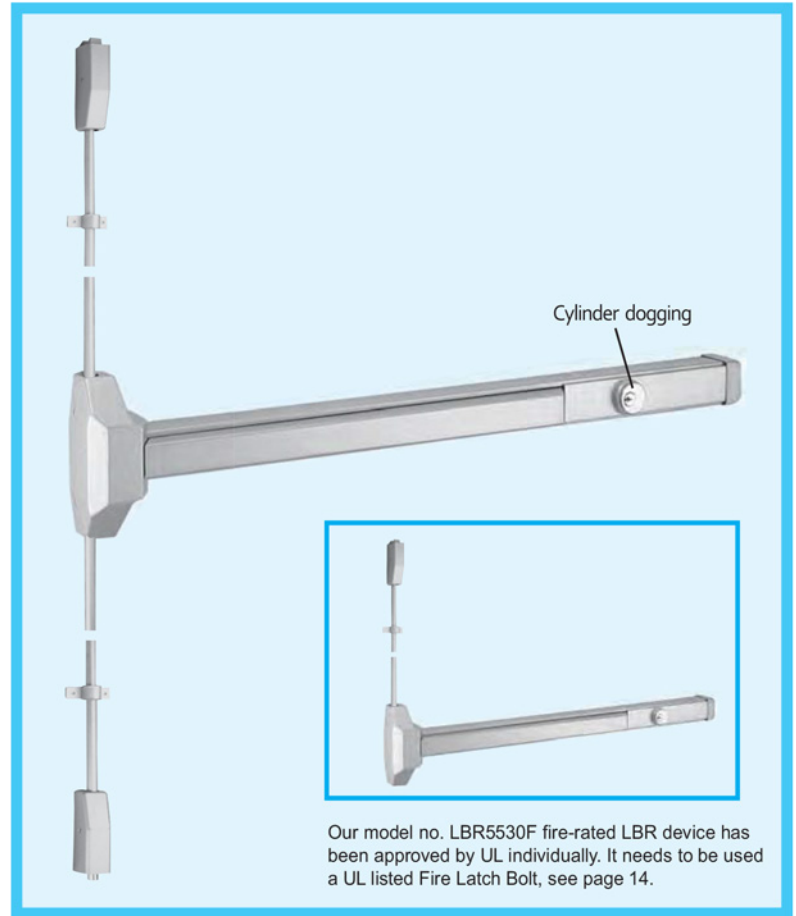

Our model no. LBR5530F fire-rated LBR device has been approved by UL individually. It needs to be used a UL listed Fire Latch Bolt, see page 14.

Specifications

Device Head Cover	Stainless Steel, nonferrous alloy
Chassis	Steel, stainless steel
Mechanism Housing	Steel or Stainless Steel
Push Bar	Steel or Stainless Steel
End Cap	Steel or Stainless Steel
Latch Bolt	100% stainless steel, 1/2" (13mm) throw
Latch Case Covers	Steel, stainless steel
Vertical Rods	Tubular aluminum with rod guides
Strikes	Top 534, Bottom 537
Handing	Non-handed

*Fire rated SVR device has no mechanical dogging. (Dogging device is not permitted on fire-rated exit device)

Mounting Fasteners	Machine screws furnished standard, Sex Nut and Bolt (SNB) are required to use for wood doors. Order SNB separately.
Dogging*	Hex key dogging standard (Allen-type key furnished)
Dogging Options	Cylinder dogging or Less dogging
Finish	605, 630, 689, 690, four finishes
Dimension	See Spec. Sheet
Device Length	See Spec. Sheet
UL Listed	For Panic Hardware, see model 900SA and Fire Exit Hardware see model 917A

International Door Closers, Inc.

COPYRIGHT 2017 INTERNATIONAL DOOR CLOSERS, INC

West: 800-544-4422 • East: 800-225-6737

www.intldoorclosers.com

RIM EXIT DEVICES

MODEL 5610S PANIC-RATED RIM EXIT DEVICE - For narrow stile exit doors made from Aluminum, Metal (HM) or Wood



Application

- For use on single doors or double doors with mullion (Fire rated device up to 4'x8' single or 8'x8' double fire labeled doors.
- Fits for 1 3/4" (44mm) thick standard non-handed or hollow metal or wood doors, other than standard 1 3/4" is available, specify door thickness.
- Minimum Stile width : 2 1/2" (63mm)

531 Strike Shim



Furnished with 532 Strike. This shim is 1/8" thick for prepared doors with 1/2" stop. It is used to obtain correct distance between the latch and the surface applied strike, when the stop is 1/2" high. If the frame has a 5/8" stop the shim is not required. Strike shim is steel and plated.



532 Panic Rim Strike

Surface applied. Standard on 5000 Series panic rim exit devices. Stainless steel with a plated roller.

Specifications

Device Head Cover	Stainless Steel, nonferrous alloy
Chassis	Steel plated
Mechanism Housing	Steel, plated
Push Bar	Steel or Stainless Steel
End Cap	Steel or Stainless Steel
Latch Bolt	100% stainless steel, deadlocking type, 11/16" (17mm) throw
Deadlocking Latch	100% stainless steel with 5/8" throw
Strikes	531 & 532 Rim type
Handing	Non-handed
Mounting Fasteners	Machine screws furnished standard, Sex Nut and Bolt (SNB) are required to use for wood doors. Order SNB separately
Dogging*	Hex key dogging standard (Allen-type key furnished)
Dogging Options	Cylinder dogging or less dogging
Finish	605, 630, 689, 690, four finishes
Dimension	See Spec. Sheet
Device Length	See Spec. Sheet
UL Listed	For Panic Hardware, see model 500SA For Fire Exit Hardware, see model 510AF

*Fire rated SVR device has no mechanical dogging. (Dogging device is not permitted on fire-rated exit device)

International Door Closers, Inc.

COPYRIGHT 2017 INTERNATIONAL DOOR CLOSERS, INC

West: 800-544-4422 • East: 800-225-6737
www.intldoorclosers.com

SURFACE VERTICAL ROD EXIT DEVICES

MODEL 5630S PANIC-RATED SVR EXIT DEVICE - For narrow stile and flush doors use

Application

- For use on all single or double doors where two-point latch is desirable (inactive leaf of double door in specialty). Fire rated device must be use on 4' x 8" single or 8' x 8" double fire labeled doors (max. size).
- Fits for 1 3/4" (44mm) thick standard RHR or LHR hollow metal door and wood doors, other than standard 1 3/4" is available but specify door thickness when ordering.
- Minimum Door Stile width: 2 1/2" (63mm).



534 Top Strike

Applied to surface of stop.
Hardened steel and plated.



537 Bottom Strike

Applied to surface of floor.
Nonferrous alloy and plated.

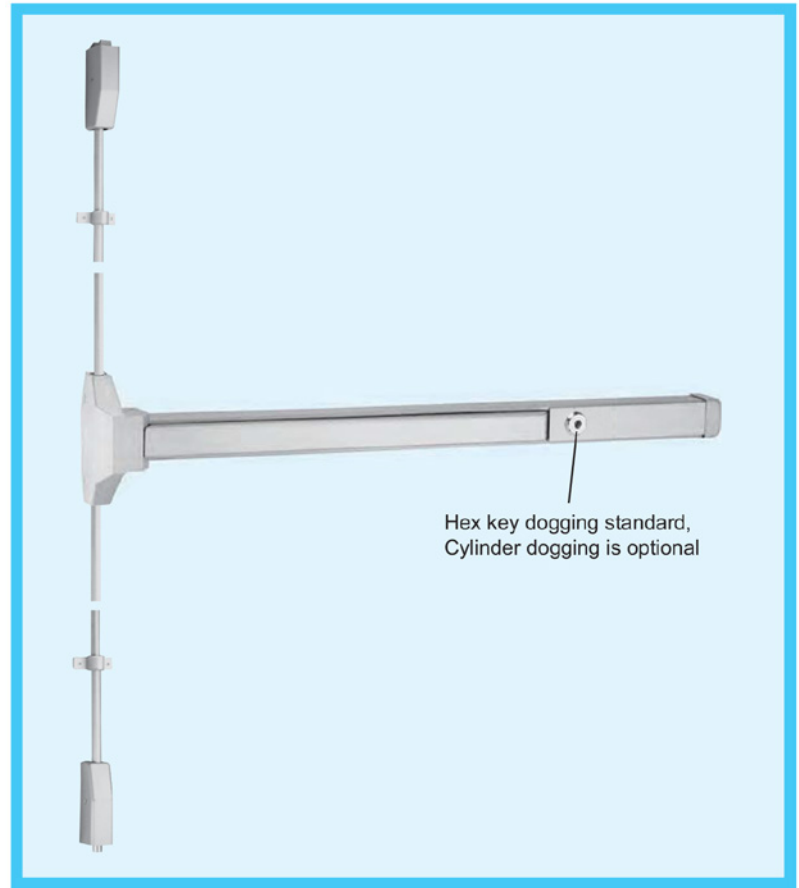

Specifications

Device Head Cover	Stainless Steel, nonferrous alloy
Chassis	Steel, plated
Mechanism Housing	Steel or Stainless Steel
Push Bar	Steel or Stainless Steel
End Cap	Steel or Stainless Steel
Latch Bolt	100% stainless steel, 1/2" (13mm) throw
Latch Case Covers	Steel, stainless steel
Vertical Rods	Tubular aluminum with rod guides
Strikes	Top 534, Bottom 537
Handing	Non-handed

Mounting Fasteners	Machine screws furnished standard, Sex Nut and Bolt (SNB) are required to use for wood doors. Order SNB separately.
Dogging*	Hex key dogging standard (Allen-type key furnished)
Dogging Options	Cylinder dogging or Less dogging
Finish	605, 630, 689, 690, four finishes
Dimension	See Spec. Sheet
Device Length	See Spec. Sheet
UL Listed	For Panic Hardware

*Fire rated SVR device has no mechanical dogging. (Dogging device is not permitted on fire-rated exit device)

International Door Closers, Inc.

COPYRIGHT 2017 INTERNATIONAL DOOR CLOSERS, INC

West: 800-544-4422 • East: 800-225-6737

www.intldoorclosers.com





DEVICE OUTSIDE TRIM

MODEL 58L SERIES ESCUTCHEON LEVERS

FEATURES:

1. Non handed, easily installed with exit device.
2. Provide 4 finishes for users and architects choosing: US3(605), US20A(690), US28(689), and US32D(630).
3. Trim has two through-bolts to the device chassis directly for more security and durability. It fits 1-3/4" (44mm) door standard. For 2" (51mm), 2-1/4" (57mm) thick door or the shim-mounted exit device, specify the door thickness when ordering.
4. The trim has four (4) models to meet different functions use, see the chart below.

Models and Functions:

Device Head Cover (Dummy trim is not recommended for fire device)	Key Locks & Unlocks Lever 	Lever Always Active (No Cylinder) 	Key Retracts Latch Bolt 	Pull when Dogged 
Function	Classroom	Passage	Night Latch	Dummy
Trim Designation	Cylinder Escutcheon Lever	Blank Escutcheon Lever	Night Escutcheon Lever	Dummy Escutcheon Lever
Model Number and Use	58L01A	58L01B	58L01C	58L01D
Escutcheon Plate Size	For 5510 Series Rim, 5530 Series Surface Vertical Rod 8 1/16" x 2 5/8" x 29/32" (205mm x 67mm x 23mm)			
ANSI Function Numbers	08	14	03	02
Cylinder Type	1/4" Mortise	-	Mortise	-

- Escutcheon is made of steel or stainless steel, lever handle is made of zinc allow.
- When there is a key requirement, the trims may receive cylinders from other manufacturers.
- Cylinder is not furnished standard. Specify cylinder type (RC-Regular Cylinder, NC-No Cylinder) when the cylinder is required.

Optional Lever Design



58L 01A
#01 Lever

58L 05A
#05 Lever

58L 17A
#17 Lever

Cylinder Selection

The cylinder has two types as shown below.



Mortis Cylinder
526

Rim Cylinder
426

MODEL 56P AND 54P SERIES STANDARD PULL PLATES

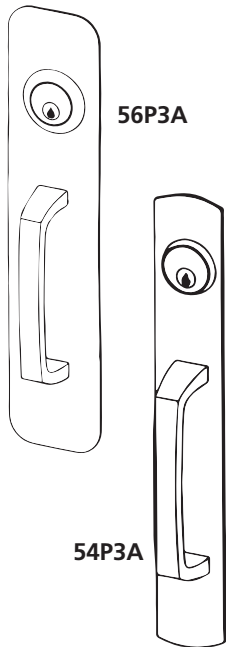

Trim Designation	Cylinder Pull Plate (with cylinder)	Dummy Pull Plate (without cylinder)	Flate Plate (without cylinder & grip)
Function	Night Latch	Dummy	N/A
Operation	Key Retracts Latch Bolt	Pull when Dogged (Not for use with a Fire Device)	N/A
Escutcheon Plate Size	56P Series - L 11 $\frac{13}{16}$ " x W 3" x T $\frac{3}{32}$ " (300mm x 76mm x 2mm) 54P Series - L 11 $\frac{13}{16}$ " x W 1 $\frac{25}{32}$ " x T $\frac{3}{32}$ " (300mm x 45mm x 2mm)		
Model Number for Wide Stile Exit Device	56P3A	56P3B	56P3D
	For 5510 Series Rim and 5530 Series SVR Devices Use		
Model Number for Narrow Stile Exit Device	54P3A	54P3B	54P3D
	For 5610S Rim and 5630S Series SVR Devices Use		
ANSI Function Numbers	03	02	10
Cylinder Types	Rim	-	-

MODEL 52R SERIES RAISED-LIP TYPE PULL PLATES



Trim Designation	Cylinder RL Type Pull Plate	Blank RL Type Pull Plate	Flate Plate (No Lips)
Function	Night Latch	Dummy	N/A
Operation	Key Retracts Latch Bolt	Pull when Dogged (Not for use with a Fire Device)	N/A
Dimensions	L 7 $\frac{11}{16}$ " x W 3" x T $\frac{1}{8}$ " (196mm x 76mm x 2mm)		
Model Number for use for Device Type	52R2A	52R2B	52R2D
	For 5510 Series Rim and 5530 Series SVR Devices Use		

- Cylinder is not furnished standard. When need to meet key requirements, the trims may receive cylinders from other manufacturers. Specify cylinder type (RC - Regular Cylinder, IC - Interchangeable Core, NC - No cylinder) when the cylinder is required.
- The face plates of these trims are made of steel or stainless steel, lever handles are made of zinc alloy.
- 52R & 56P Series trims can retrofit 1 3/4" steel doors prepped for bored locks (per ANSI A115.2).
- 54P & 56P Series trims furnish mounting through-bolts, 52R Series trim furnishes sex nuts and bolts (SNB).
- Supply US3(605), US32D(630), and US28(689).
- To Order: Specify model numbers, cylinder type, finish code and add door thickness if the door is thicker than 1 3/4". For example: 52R2A-RC-630



LEVERS

MODEL 55K AND 53K SERIES ROUND ROSE LEVERS

FEATURES:

1. Non-handed, easily installed with exit device.
2. Easy operating lever handle allows convenient one hand operation.
3. Available finishes: US3(605), US20A(690), US28(689) and US32D(630).
4. Trim has two through-bolts to the device chassis directly for more security and durability.
5. The actuating shaft of this trim is made of hardened steel bar, it fits 1 3/4" (44mm) doors standard for 2" (51mm), 2 1/4" (57mm) thick door or the shim-mounted exit device, specify the door thickness when ordering.
6. Clutch freewheeling design. The lever rotates when the door is locked preventing excessive force from being applied to the horizontal lever.

Models and Functions:

Operation Options		Key Locks & Unlocks Lever	Key Retracts Latch Bolt	Lever Always Active (No Cylinder)	Pull when Dogged
					
Function		Classroom	Storeroom Night Latch	Passage	Dummy
Trim Designation		Cylinder Round Rose Lever	Night Latch Round Rose Lever	Blank Round Rose Lever	Dummy Round Rose Lever
Model Number and Use		55K01A	55K01C	55K01B	55K01D
		53K01A	53K01C	53K01B	53K01D
For Rim, Surface Vertical Rod Exit Device Use					
Dimensions	55 Series	Rose diameter 3 3/8" (86mm). Lever length 4 3/4" (121mm), Projection 3" (76mm)			
	53 Series	Rose diameter 3 1/16" (78mm). Lever length 4 3/4" (121mm), Projection 3" (76mm)			
ANSI Function Numbers		08	03	14	02

- Rose Trim is made of steel or stainless steel, lever handle is made of zinc alloy.
- When need to meet key requirement, the trims may receive cylinders from other manufactures.
- Cylinder is not furnished standard. Specify cylinder type (RC-Regular Cylinder, IC - Interchangeable Core, NC - No Cylinder) when the cylinder is required.
- 55k Series trims can fit and cover cutout of 1 3/4" steel doors prep for bored locks with lever handles (per ANSI/BHMA A156.115).

How to order for 55K or 53K Series Trims:

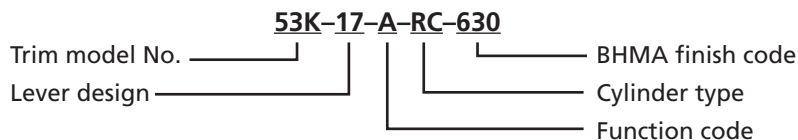

Function code:

- A - Classroom
- B - Passage
- C - Storeroom
- D - Dummy

International Door Closers, Inc.

COPYRIGHT 2017 INTERNATIONAL DOOR CLOSERS, INC

West: 800-544-4422 • East: 800-225-6737

www.intldoorclosers.com

ACCESSORIES

FIRE LATCH BOLT, MODEL FLOOR

Fire latch bolt is used with a pair of UL listed fire rated LBR exit devices, it includes a spring and stainless steel bolt which installs in the lower door edge inside to replace the bottom vertical rods of two SVR exit devices on a double door. This UL listed fire latch bolt is a temperature-actuated bolt that is designed to release from one door leaf and engage the other door when the temperature exceeds the rating of the fusible link during a fire. When the fire latch bolt releases and connects with the opposite door leaf, it keeps the doors in alignment and closed during a fire.

Specifications

- UL listed, furnished with LBR device
- Faceplate: 1-25/32" x 1" (45mm x25.6)
- Bolt diameter: 27/32" (21.6mm)
- Length of Latch Bolt: 3-5/32" (80mm)
- Material: 100% stainless steel

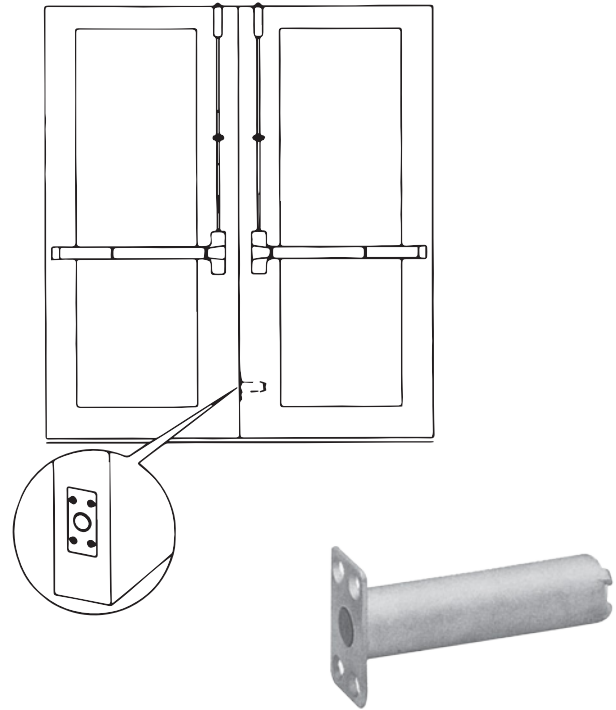

DOGGING OPTIONS

Less Dogging (LD)

Less Dogging is available on all 5000 Series Panic Exit Devices when users want to remove the dogging option.



Cylinder Dogging (CD)

Cylinder Dogging is available on all 5000 Series Panic Exit Devices to replace the standard hex key dogging. Unit requires a standard 1-1/4" (32mm) mortise cylinder with a straight cam.

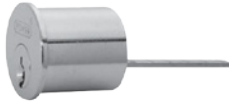

CYLINDER OPTIONS

Cylinders are not furnished with device or trim and must be specified when required. Refer to the trim pages for cylinder type.

	Mortise Cylinder	Rim Cylinder
Regular Type	 526	 426
Interchangeable Core Type	 208	 308