



ADJUSTABLE SPRING POWER SURFACE APPLIED GRADE 1 CLOSER

44CI SERIES

HEAVY DUTY CAST IRON

FEATURES

- Application for HIGH TRAFFIC Doors
- Cast Iron Body; Forged Steel Arm
- Double Heat Treated Steel Pinion
- All Weather Fluid
- Non-Handed
- Non-Sized Adjustable 1 Through 6; Standard with Back Check
- Universal Application for Regular Arm, Top Jamb, or Parallel Arm Mounting
- Standard Plastic Cover - Non Handed
- Hold-open arms are adjustable for holding from 85° to 180°.
- 10 year Warranty



OPTIONS AVAILABLE

- Metal Cover
- Heavy Duty Arm (EDA)
- Hold-Open arm
- Stop Only Arm
- Friction Hold Open Arm



[View 3D Model Online](#)

FINISHES

- AL - Aluminum
- DU - Storefront Bronze

10 YEAR WARRANTY

COMPLIANCE STANDARDS

- ANSI/BHMA A156.4 Grade 1 Certified
- UL/C-UL Listed
- UL 10B and UL 10C Compliant for positive pressure
- Certified to Conform to UBC 7-2 (1997, UL 228)
- Barrier Free Operation to Comply with Federal Accessibility Standards (ADA): Complying with ANSI A117.1 (4.13.11)

(Other finishes available by Special Order)

TECHNICAL DIMENSIONS

Description	Dimensions
A. Length of Closer Body (With Cover)	12-1/4"
B. Horizontal Mounting Holes	SEE DRAWING
C. Vertical Mounting Holes	2-1/4"
D. Overall Height	4-7/8"
E. Top of Door to Bottom of Closer	3-11/16"
F. Closer Body Height	3-1/2"
G. Projection from Door	2-1/4"

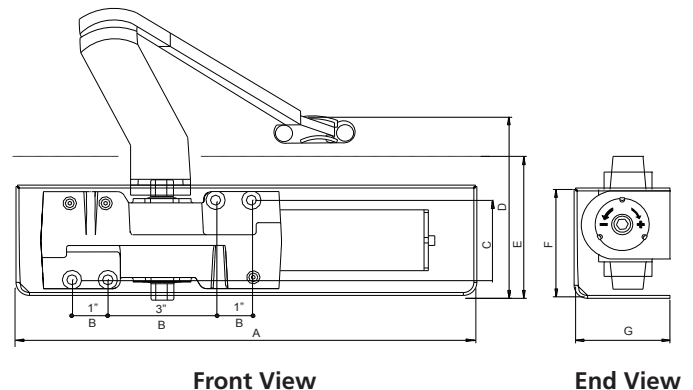

International Door Closers, Inc.

COPYRIGHT 2017 INTERNATIONAL DOOR CLOSERS, INC

West: 800-544-4422 • East: 800-225-6737

www.intldoorclosers.com

INSTALLATION TYPES

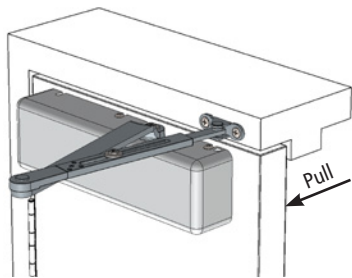

Regular Arm (Pull Side)
Permits 120° maximum opening

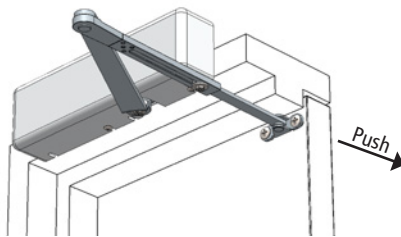



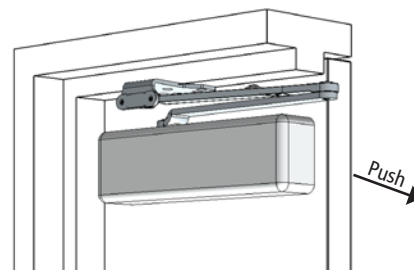





Top Jamb (Push Side)
Permits 120° maximum opening



Parallel Arm (Push Side)
Permits 180° maximum opening

PARTS AND ACCESSORIES

PART NO.

	Plastic Dress Cover	DC-44
	Metal Dress Cover (special order)	DC-44M
	Complete Arm Assembly	44-2021
	Cushion - Hold-open arm - Mechanical Turn Type	44-2022
	Cushion Stop Arm	44-2023
	Friction Hold Open Arm	44-2024
	Heavy Duty Arm (EDA)	44-2026
	Parallel Bracket	425
	Drop Plate for Pull Side installation when top Door Rail is less than 3-3/4". Requires a 2" minimum height Door Rail.	44-18
	Drop Plate for Top Jamb installation when ceiling is flush to top of Header. Requires a minimum 1-3/4" header height.	44-18G
	Drop Plate for Top Jamb installation on Door Headers less than 3-1/2" in height.	44-18J
	Drop Plate for Parallel Arm installation on Door Rails less than 5-1/2" (measured down from the door stop). Requires a 2" minimum height Door Rail.	44-18PA

SPECIFY FINISH:
 • AL - Aluminum
 • DU - Storefront Bronze